

**COMPETITOR SERIES®**

**C-BB48-HC**

**C-BB60-HC**

**C-BB72-HC**

# SOLID DOOR BACK BAR REFRIGERATORS

- Beautiful ergonomic construction
- Black corrosion resistant steel exterior, stainless steel interior and stainless steel top
- Digital temperature controller and read-out
- Forced air refrigeration system
- Side mount compressor
- Recessed door handles
- LED interior lighting
- Door locks
- Leveling feet included
- Accessory: optional casters upon request
- All Natural R290 Hydrocarbon Refrigerant
- US Department of Energy Certified
- Migali® Protection Plan: 2 Year Parts & Labor Warranty, 5 Years Compressor Warranty

MODEL	DOORS	CAPACITY CU/FT	STORAGE CAPACITY	SHELVES	H/P	AMPS	VOLTAGE	PLUG TYPE	TEMP RANGE	EXTERIOR DIMENSIONS W X D X H	INTERIOR DIMENSIONS W X D X H	PACKAGED DIMENSIONS W X D X H	WEIGHT	PACKAGED WEIGHT
C-BB48-HC	2	13	546 (12 oz.) cans 336 (12 oz.) bottles 2 (1/2 barrel) kegs	4	1/5	2.8	115/60/1	Nema 5-15P	+33° F (-) +38° F	48.75 x 24.4 x 35.7	36.25 x 18.5 x 28.9	51.25 x 27.5 x 41.75	231 lbs.	282 lbs.
C-BB60-HC	2	17.3	756 (12 oz.) cans 456 (12 oz.) bottles 2 (1/2 barrel) kegs	4	1/5	2.8	115/60/1	Nema 5-15P	+33° F (-) +38° F	60.75 x 24.5 x 35.7	48.25 x 18.5 x 29	63.5 x 27.5 x 41.75	276 lbs.	319 lbs.
C-BB72-HC	3	21.6	966 (12 oz.) cans 576 (12 oz.) bottles 3 (1/2 barrel) kegs	6	1/3	3.96	115/60/1	Nema 5-15P	+33° F (-) +38° F	72.75 x 24.5 x 35.7	60.2 x 18.5 x 31.5	75.25 x 27.5 x 41.75	331 lbs.	374 lbs.

**Accessories:**

- Caster - stem - with brake ( 5-3/4" overall ) - Part Number 1597-01
- Caster - plate - with brake ( 5-1/4" overall ) - Part Number 2481-329

**FOR COMMERCIAL USE ONLY**
**NOTE: MIGALI® RESERVES THE RIGHT TO CHANGE SPECIFICATIONS WITHOUT NOTICE**

**TOLL FREE: 800.852.5292**  
**WEB: www.migali.com**

# DIMENSIONAL DRAWINGS

**C-BB48-HC**

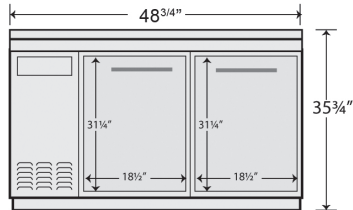

**C-BB60-HC**

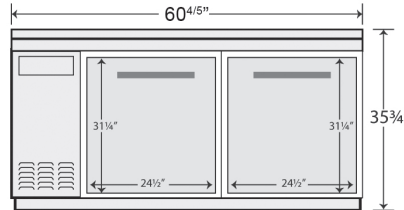

**C-BB72-HC**

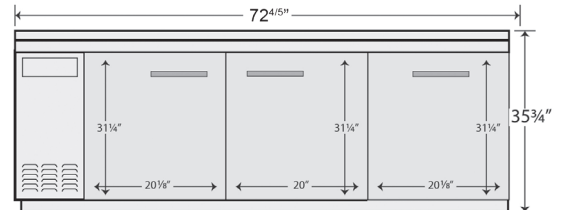

**C-BB48-HC  
TOP VIEW**

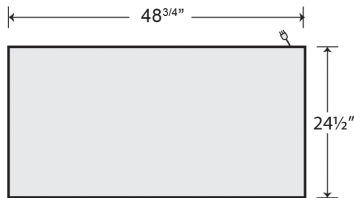

**C-BB60-HC  
TOP VIEW**

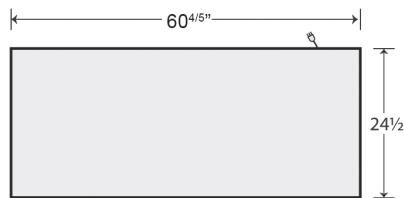

**C-BB72-HC  
TOP VIEW**

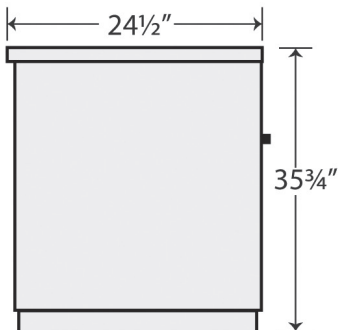
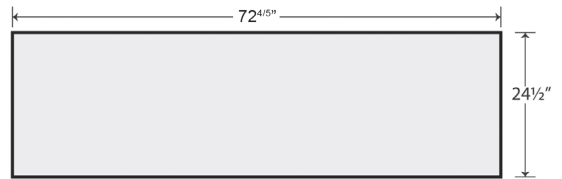

**SIDE VIEW (1,2,3) DOOR MODELS**



MIGALI® REMAINS AN AMERICAN FAMILY COMPANY SINCE 1955